



®

CORPORATION

FLAME ARRESTER

MODEL 7658A

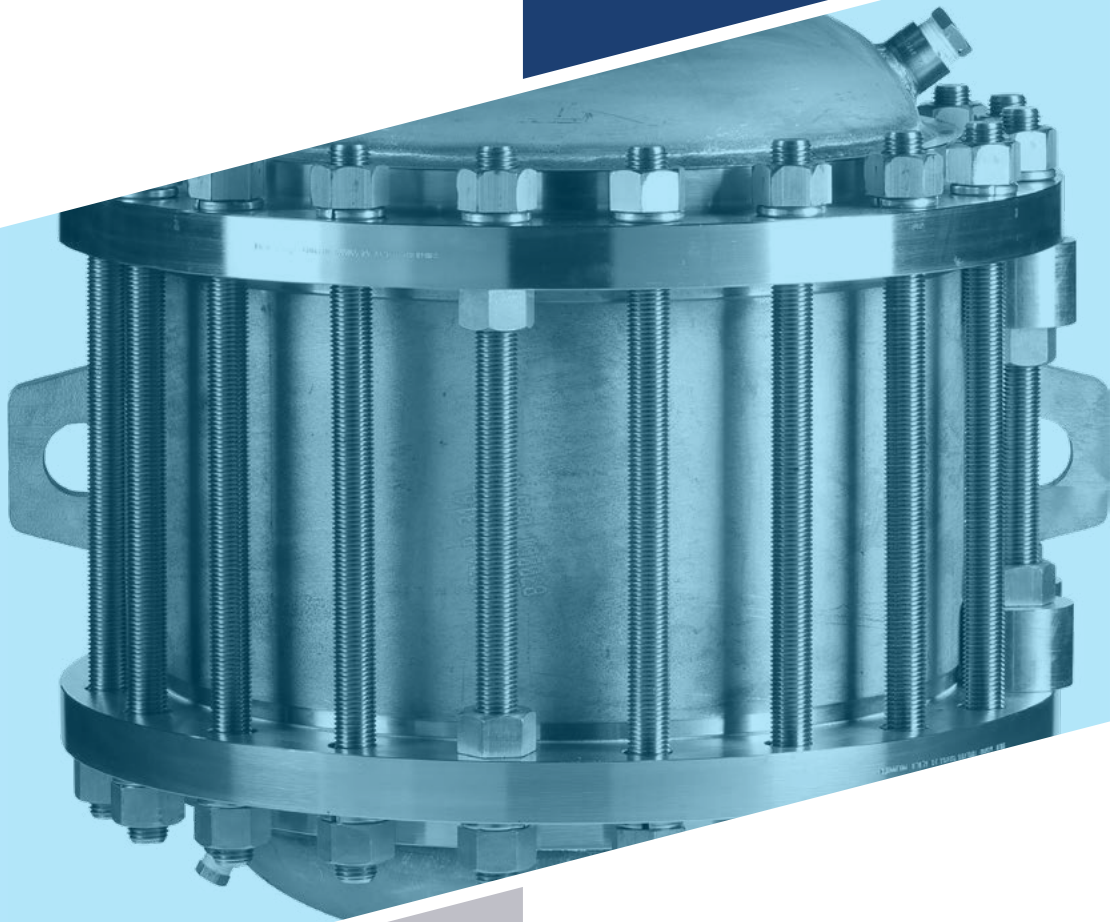

MODEL 7658A

The Groth Model 7658A Deflagration & Detonation Flame Arrester inhibits flame propagation in gas piping systems. The design makes it ideal to protect liquid storage tanks containing NEC Group D (IEC Class IIA) gases.

Technical Details

- Sizes: 2" (DN50) x 5" (DN125) through 8" (DN200) x 16" (DN400)
- Housings Materials: Carbon Steel, Stainless Steel, Alloy C276
- Element Materials: Stainless Steel, Alloy C276 or other corrosion resistant alloys
- Consult the factory for specific information by size for Stable/Unstable detonations and deflagrations
- Vertical or horizontal installation
- Pre-ignition system pressure up to 15.7 psia (1.08 bara)
- Pre-ignition system temperatures -4 to 140°F (-20 to 60°C)
- Burn time tBT 10 minutes
- Many sizes certified to ATEX and/or US Coast Guard, please consult factory for information

Features

- Compact with high flow capacity and low pressure drop
- Elements are easily removed in-line for cleaning and maintenance

Options

- Sensor ports
- Large inspection and cleaning ports
- Swing bolts for fast element removal
- Factory installed thermocouples for flame sensing



SPECIFICATIONS

Housing Size Inches (mm)	A Width Inches (mm)	B Height Inches (mm)	Approx Ship. Weight Lbs (kg)
5 (125)	17.5 (445)	9 (229)	76 (34)
6 (150)	20.21 (516)	11 (279)	100 (45)
8 (200)	22.43 (570)	13.5 (343)	175 (79)
12 (300)	25.94 (659)	19 (483)	350 (159)

* Larger sizes available on special applications.
All units with ANSI 150 RF flanges standard (other flange drillings available).

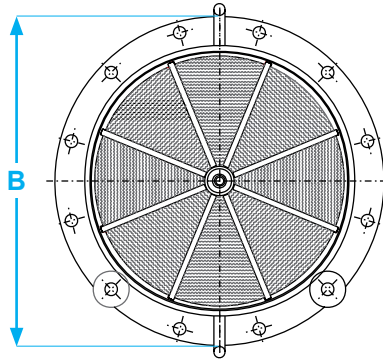
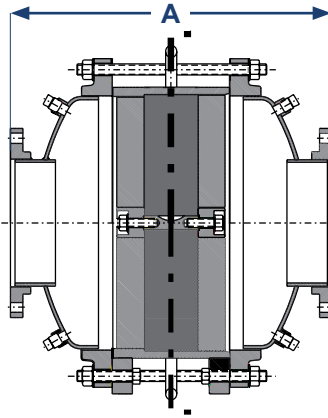

FLOW CAPACITY

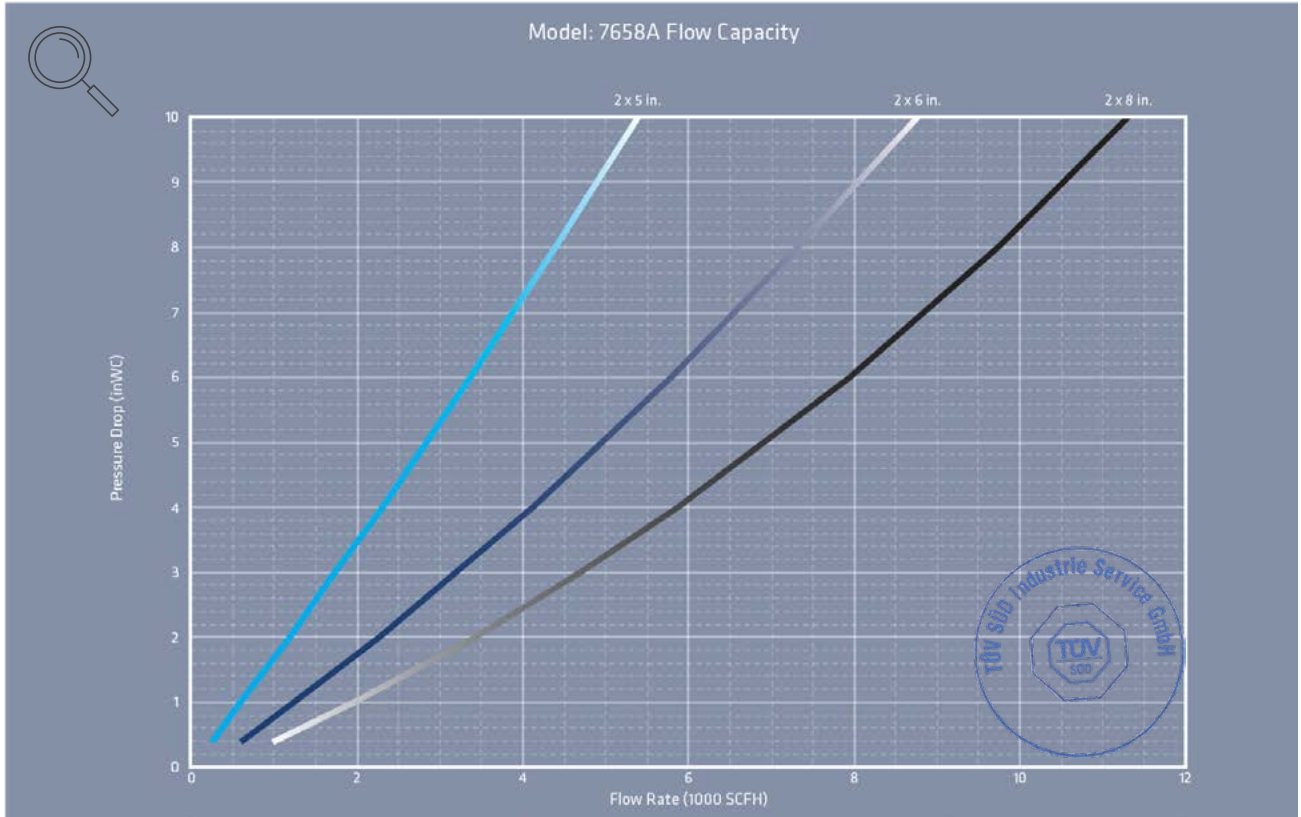
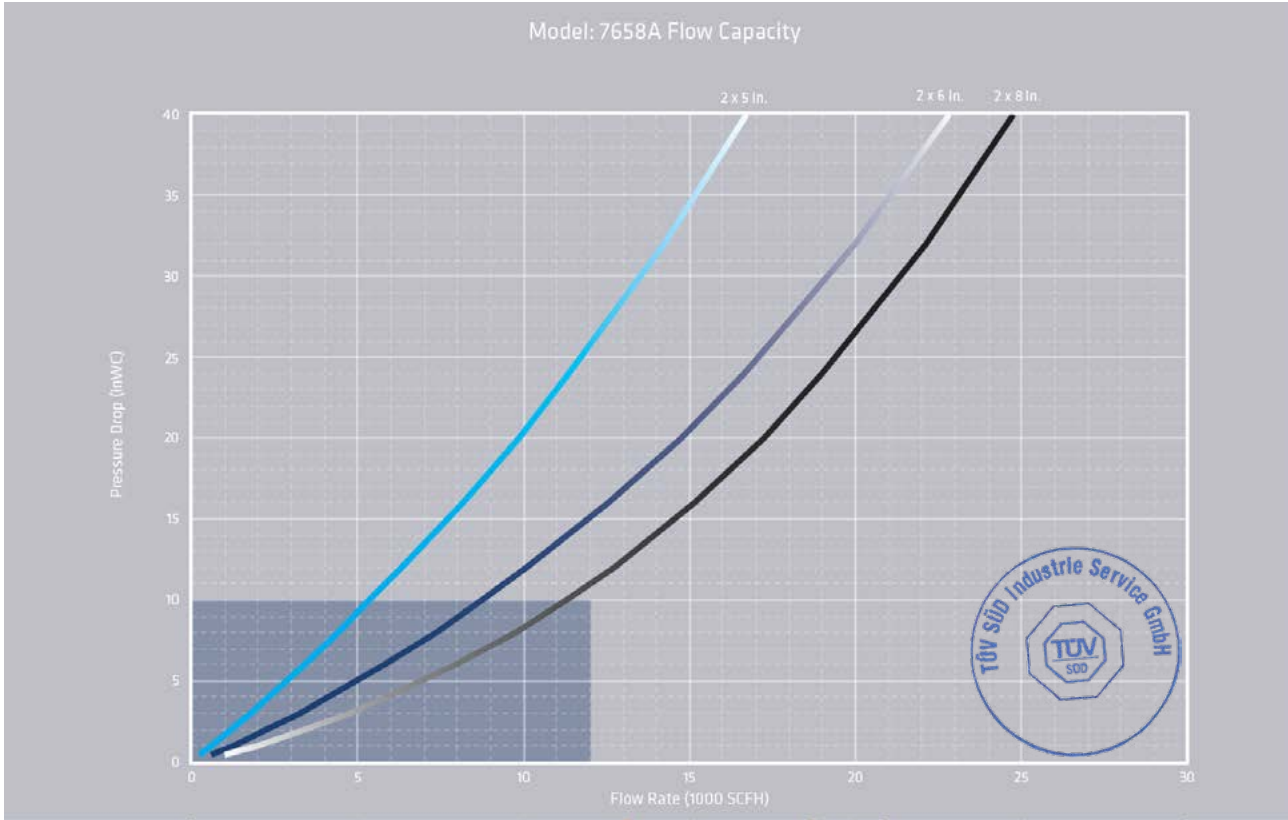

- The test equipment, procedures, and reporting methods utilized by Groth Corporation meet the requirements of standards API 2000/ISO 28300 and ISO 16852. The equipment, methods, and results have been reviewed and certified by TÜV SÜD.
- Flow data are for in-line mounting and does not include entrance losses or exit losses.
- Flow values based on air at 60°F venting to atmospheric pressure of 14.6959 psia

FLOW CAPACITY

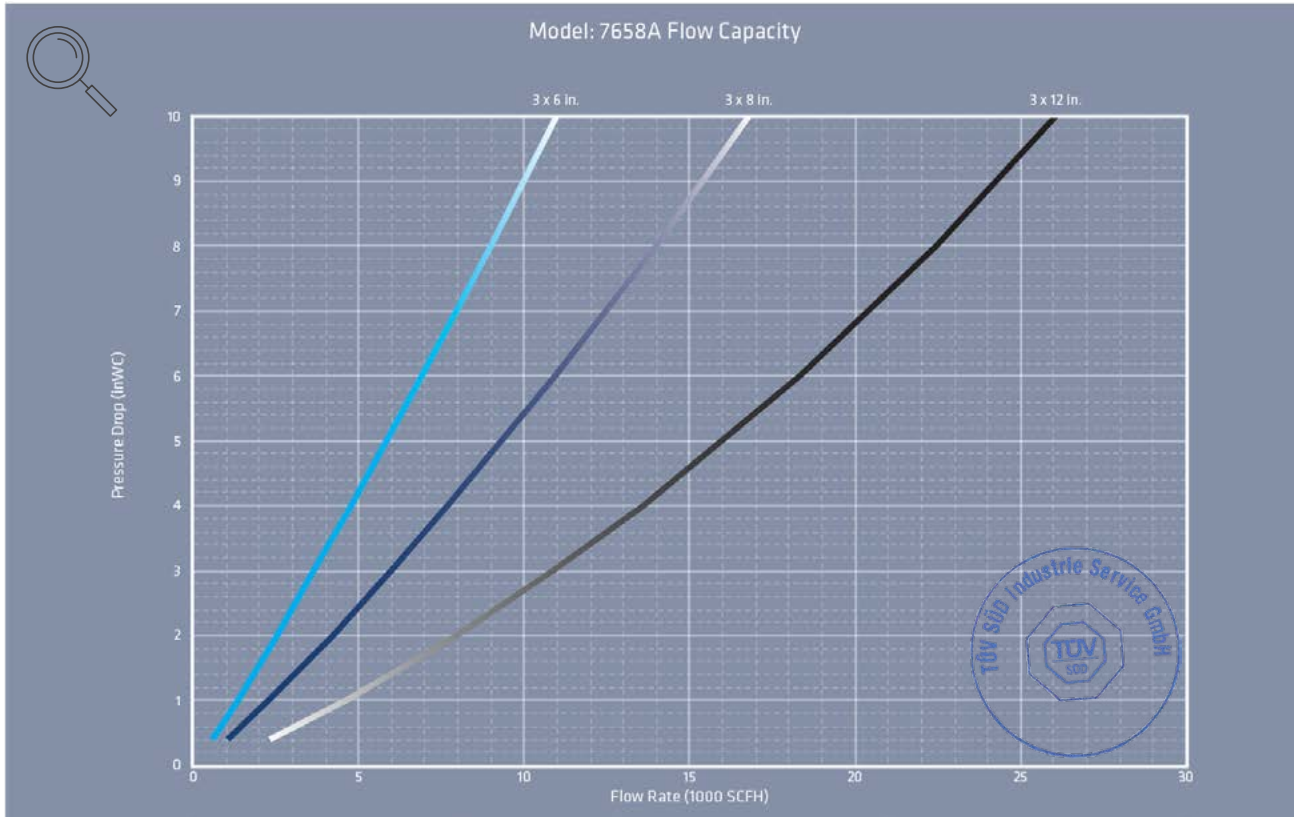
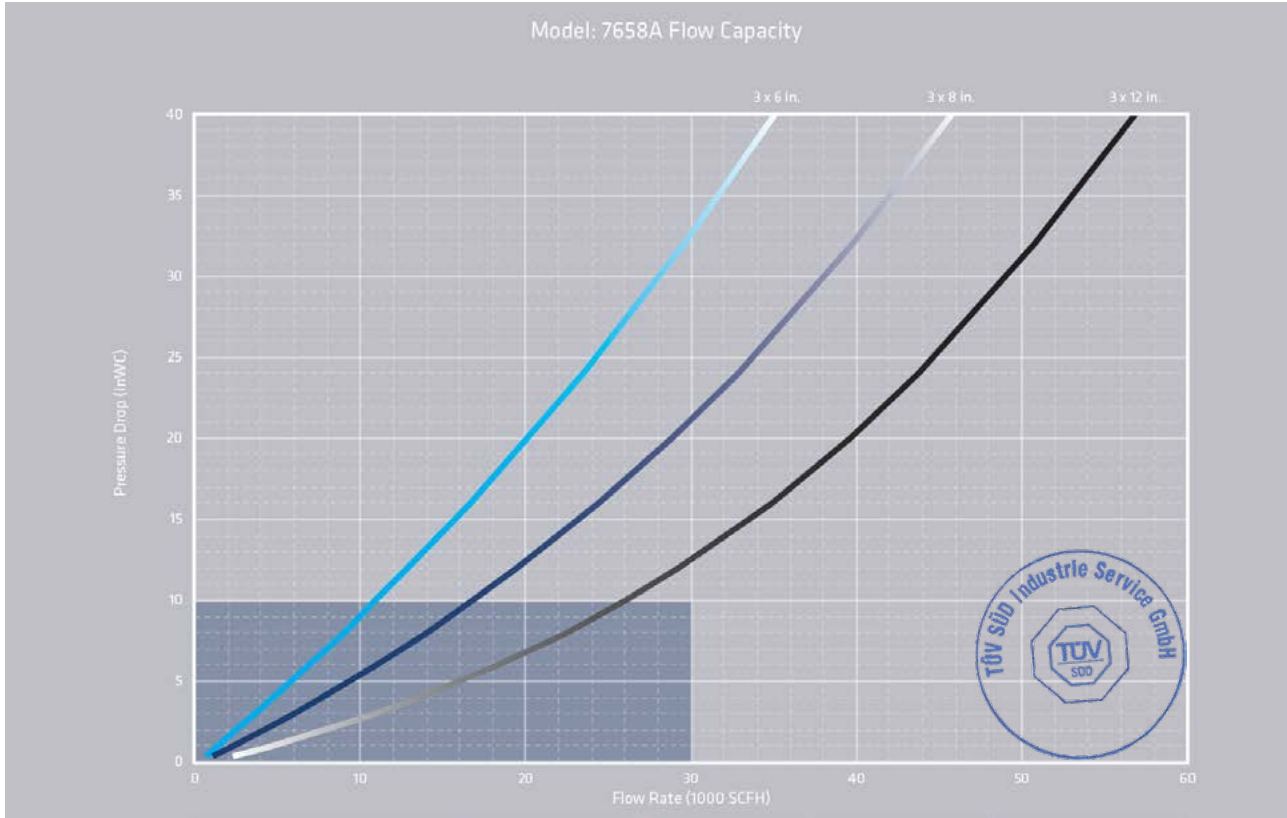

- The test equipment, procedures, and reporting methods utilized by Groth Corporation meet the requirements of standards API 2000/ISO 28300 and ISO 16852. The equipment, methods, and results have been reviewed and certified by TÜV SÜD.
- Flow data are for in-line mounting and does not include entrance losses or exit losses.
- Flow values based on air at 60°F venting to atmospheric pressure of 14.6959 psia

FLOW CAPACITY

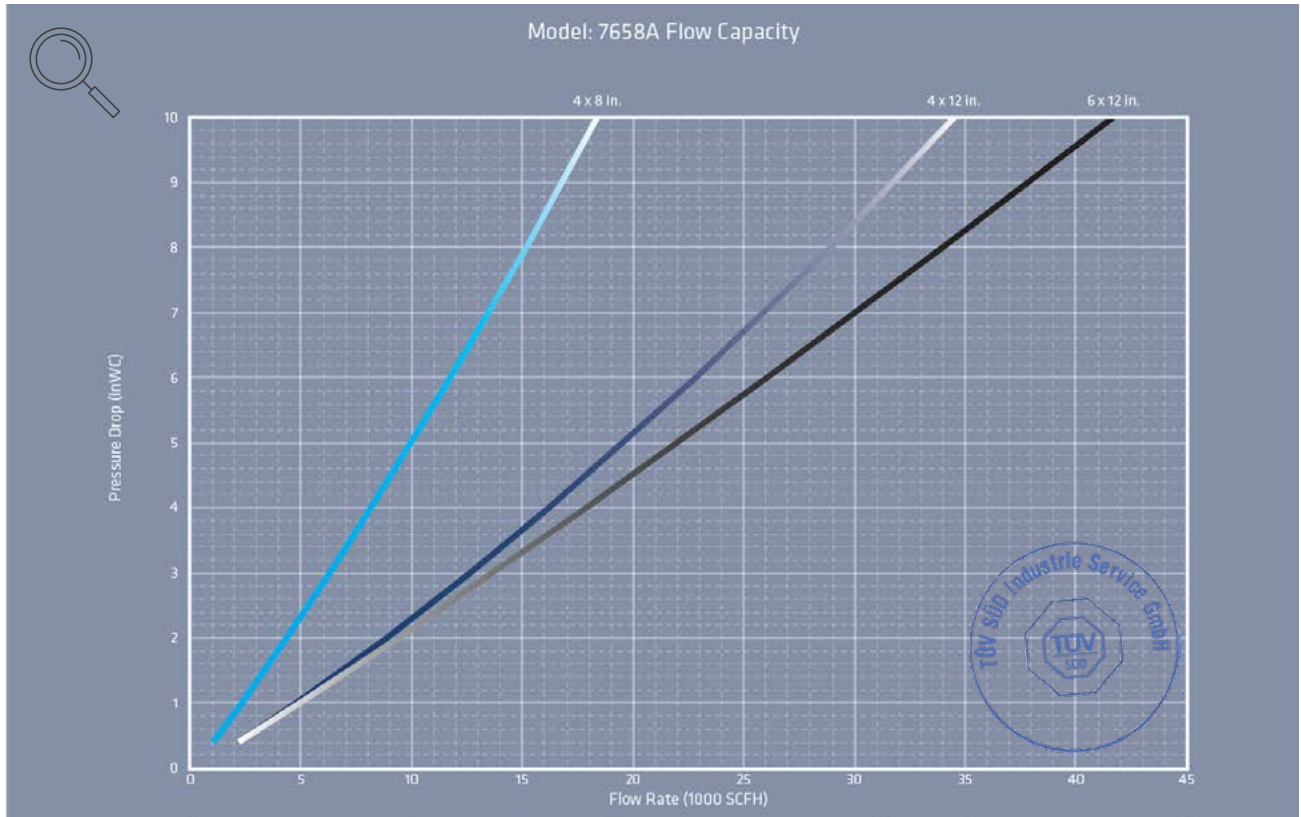
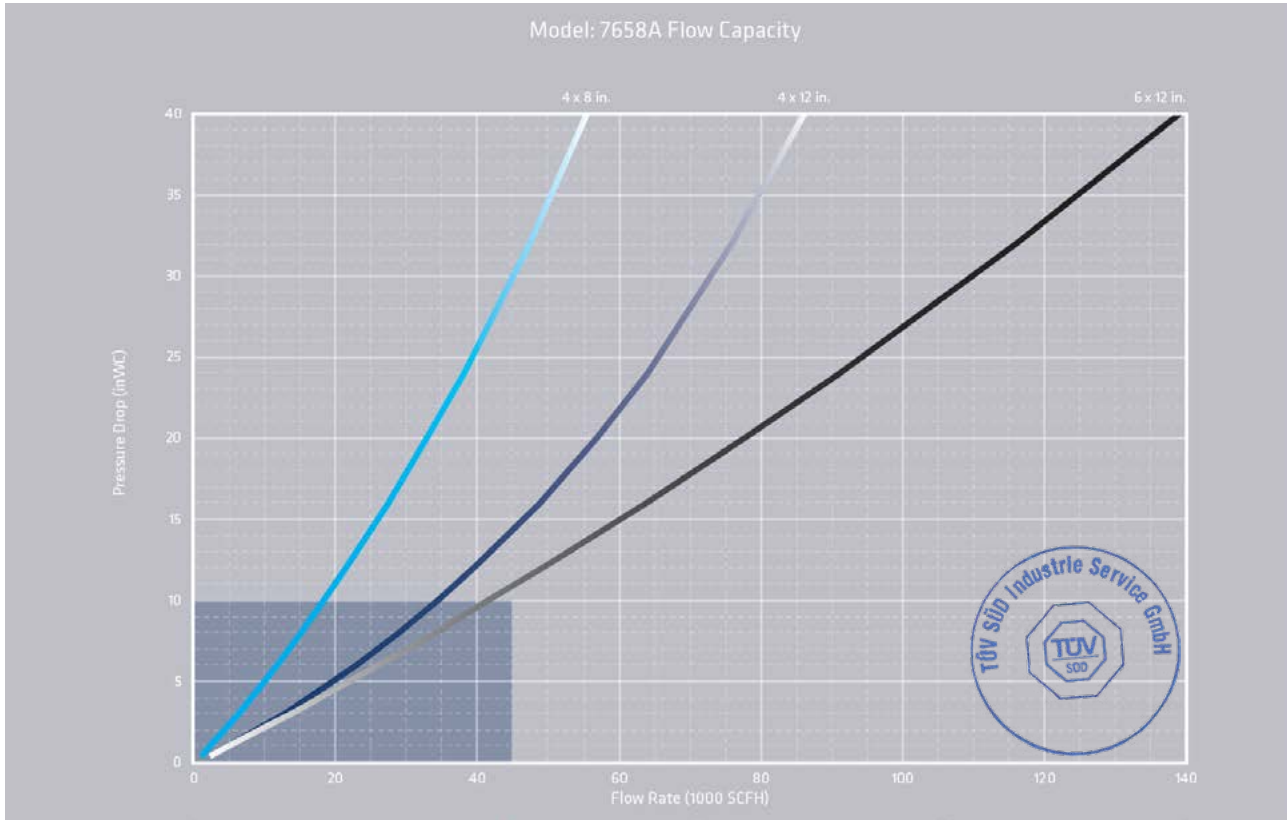

- The test equipment, procedures, and reporting methods utilized by Groth Corporation meet the requirements of standards API 2000/ISO 28300 and ISO 16852. The equipment, methods, and results have been reviewed and certified by TÜV SÜD.
- Flow data are for in-line mounting and does not include entrance losses or exit losses.
- Flow values based on air at 60°F venting to atmospheric pressure of 14.6959 psia

FLOW CAPACITY

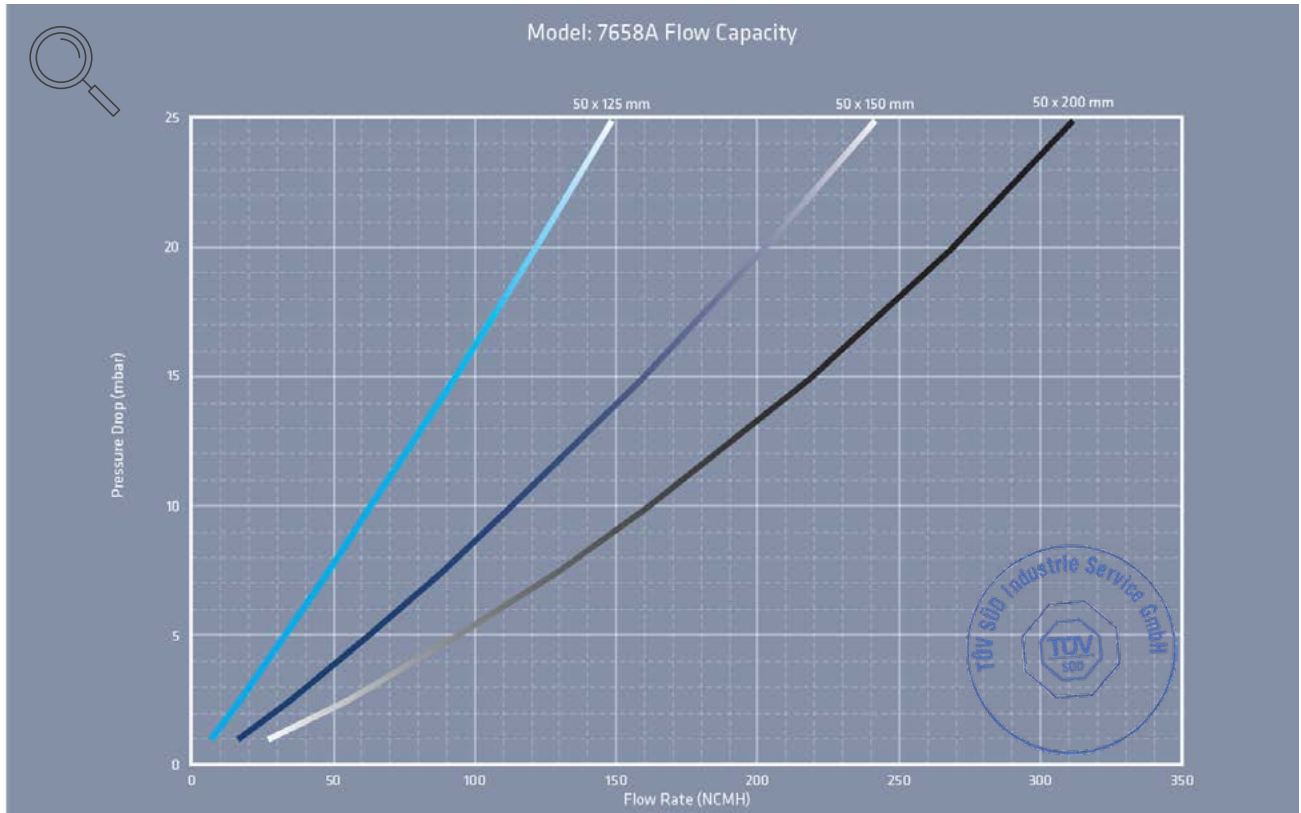
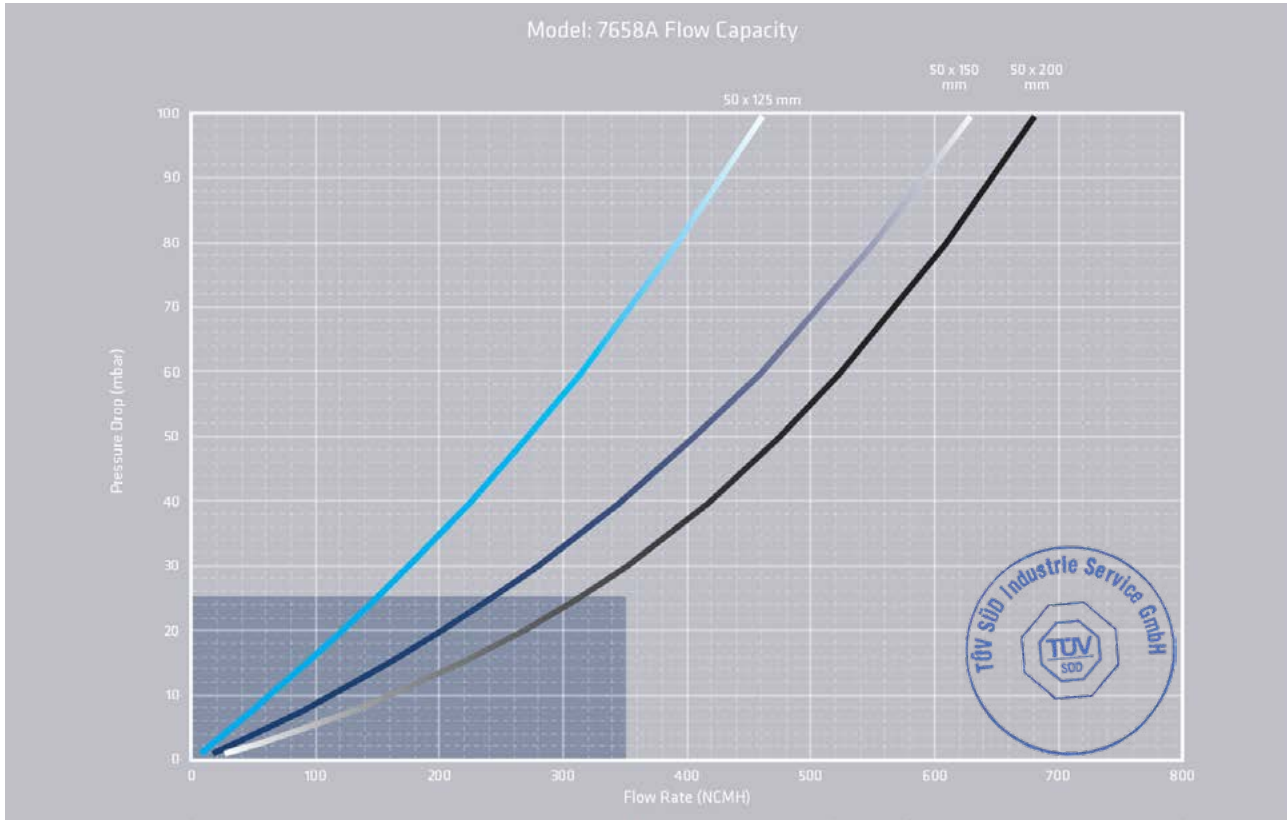

- The test equipment, procedures, and reporting methods utilized by Groth Corporation meet the requirements of standards API 2000/ISO 28300 and ISO 16852. The equipment, methods, and results have been reviewed and certified by TÜV SÜD.
- Flow data are for in-line mounting and does not include entrance losses or exit losses.
- Flow values based on air at 0°C venting to atmospheric pressure of 1.01325 bara

FLOW CAPACITY

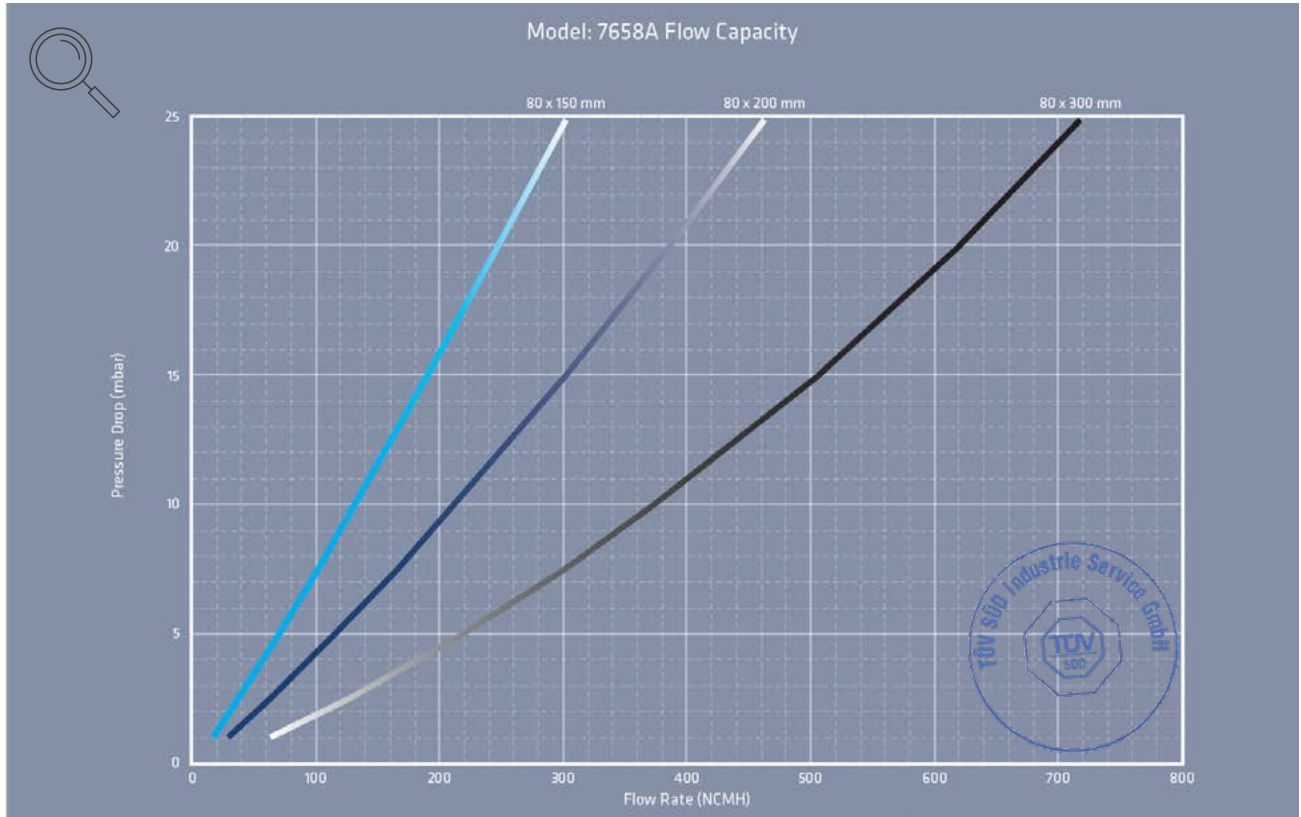
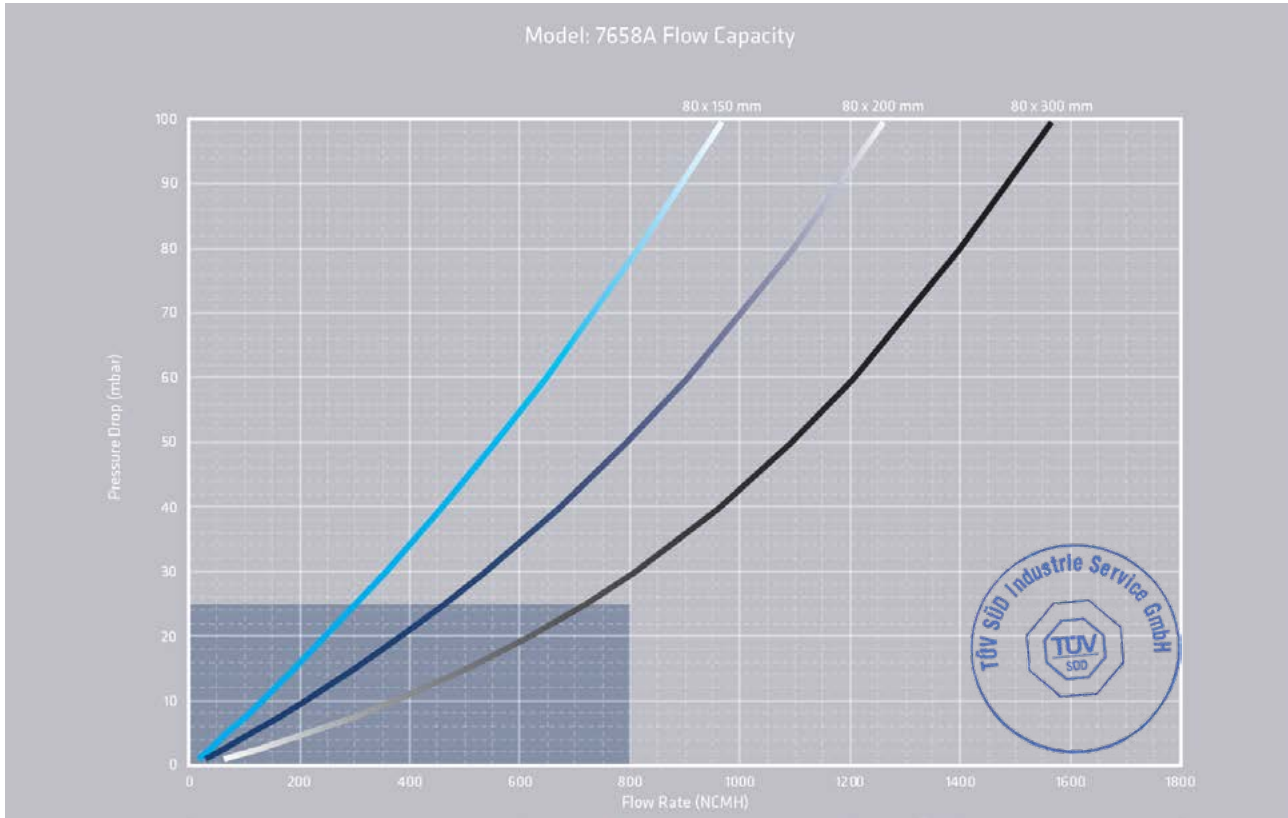

- The test equipment, procedures, and reporting methods utilized by Groth Corporation meet the requirements of standards API 2000/ISO 28300 and ISO 16852. The equipment, methods, and results have been reviewed and certified by TÜV SÜD.
- Flow data are for in-line mounting and does not include entrance losses or exit losses.
- Flow values based on air at 0°C venting to atmospheric pressure of 1.01325 bara

FLOW CAPACITY

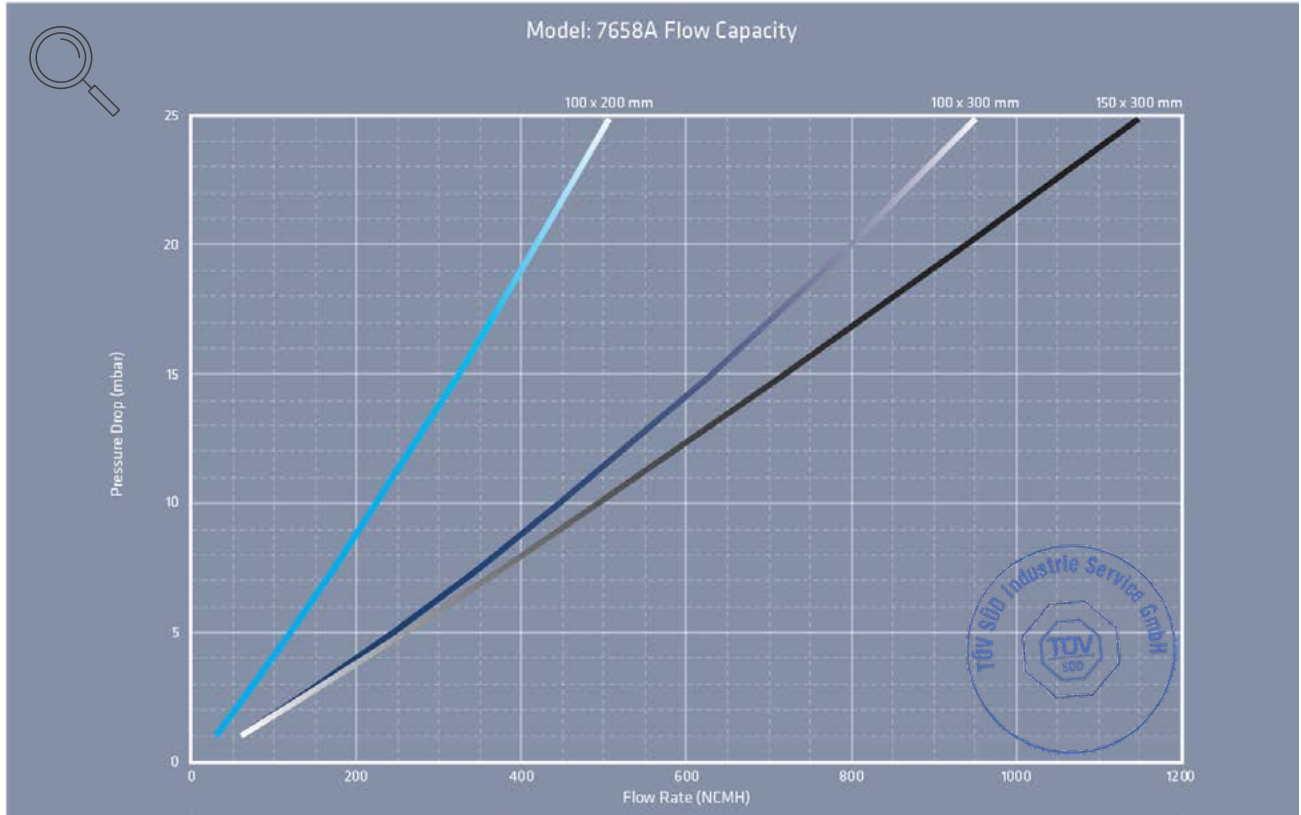
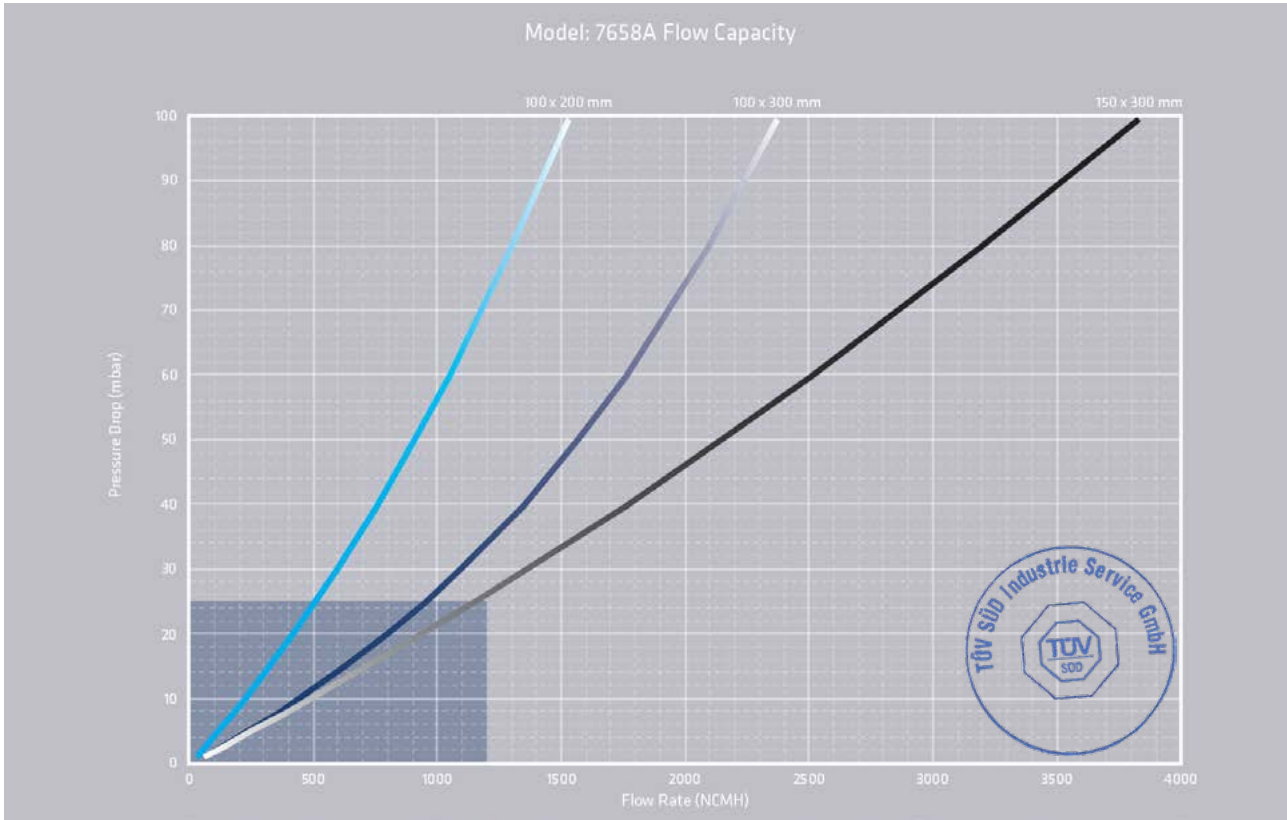

- The test equipment, procedures, and reporting methods utilized by Groth Corporation meet the requirements of standards API 2000/ISO 28300 and ISO 16852. The equipment, methods, and results have been reviewed and certified by TÜV SÜD.
- Flow data are for in-line mounting and does not include entrance losses or exit losses.
- Flow values based on air at 0°C venting to atmospheric pressure of 1.01325 bara

HOW TO ORDER

For easy ordering, select proper model numbers

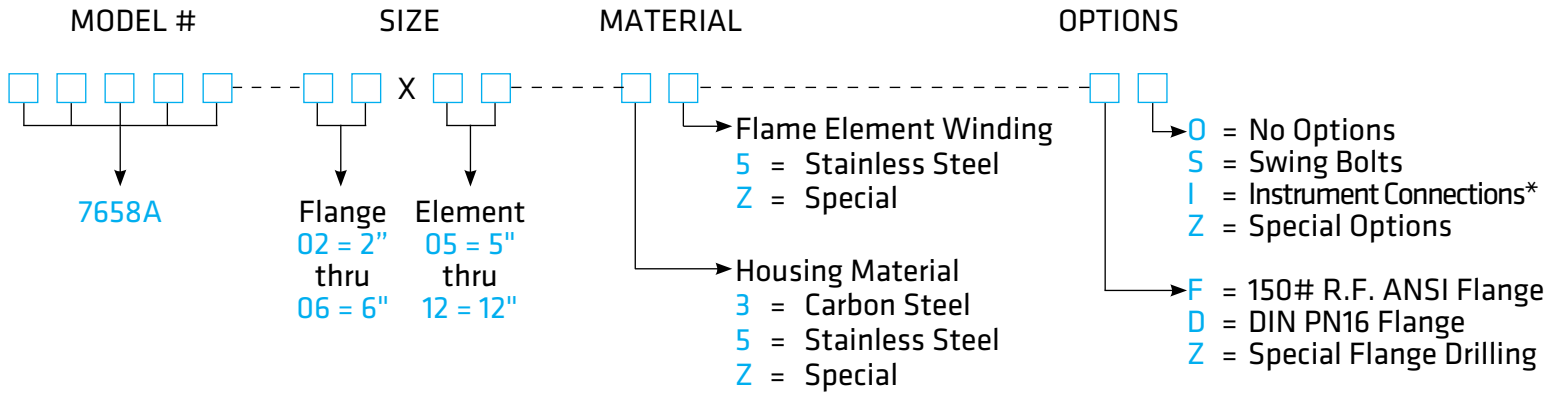

Notes

- Include model number when ordering.
- For special options, consult factory.
- See flow table for available sizes.
- * Customer specified size

Example

7 6 5 8 A - 0 3 X 0 6 - 3 5 - F 0

Indicates a 3" Model 7658A with Carbon Steel housing, 6" Stainless Steel Flame Element, ANSI Flanged Outlet and no other options.

The logo consists of a large square frame divided into four quadrants. The top-left and bottom-right quadrants are white, while the top-right and bottom-left quadrants are a dark gray. In the center of the frame, the word "GROWTH" is written in a bold, white, sans-serif font. Below the word, a stylized "L" is formed by the white background of the bottom-left quadrant, and a stylized "G" is formed by the dark gray background of the bottom-right quadrant.

GROWTH

®

CORPORATION



GROTHCORP.COM